

InEL IR-Cam (NTSC/PAL)

mixed thermal FPV solution



User Manual

V1.2

Contents

1. Overview.....	3
2. Box Content.....	6
3. Dimensions.....	7
4. Setup Hardware.....	8
4.1 Flight Controller (FC).....	8
4.2 IR-Cam Base.....	9
4.3 IR-Cam Module.....	10
4.4 1-axis Gimbal (Servo).....	11
5. Settings.....	13
5.1 Quick Setup (Overview).....	14
5.2 FPV Camera Passthrough.....	15
5.3 RC Settings.....	15
5.4 Thermal Settings.....	16
5.5 Servo Settings.....	17
5.6 Thermal Profile Selection.....	18
5.7 Setup thermal profiles (Advanced).....	19
6. Firmware Update.....	20
7. Specifications.....	21
8. Compliance.....	21
9. Safety information.....	21
10. Help / Troubleshooting.....	22

Copyright © 2024, Inntal Electronic Loecker GmbH

Visit www.inel-fpv.at to get more information.



1. Overview

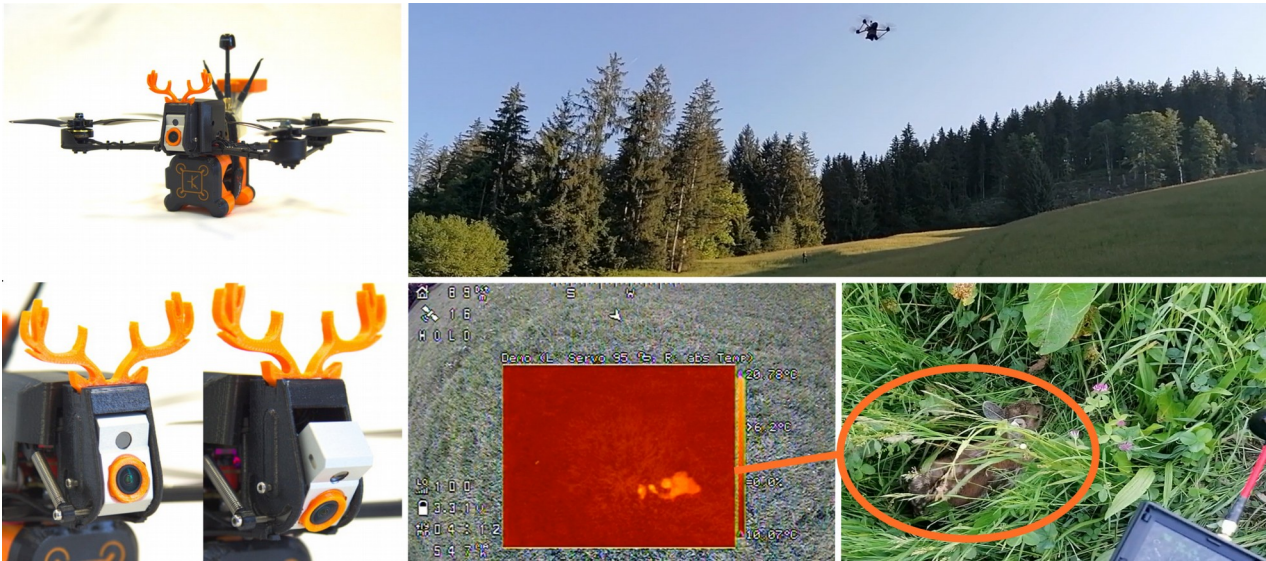

InEL IR-Cam is designed from FPV-pilots for FPV-pilots. It merges visible images with thermal images for the primary usage on **FPV** (first person view) drones or other RC hobby devices. Low latency of the visual camera is in combination with the thermal view to find anything anywhere.

The resolution and frame-rate of small thermal sensors is too low to orient oneself with a FPV drone without restraints. **InEL IR-Cam** takes the visible video stream (**PAL or NTSC**) and merges the data of the thermal sensor into it. It's bare metal design and state of the art **FPGA** technology results in a minimized additional latency of the visible video stream smaller than **0.1ms**.

It's designed for hand on based FPV-pilots and suits best for INAV build-ups. It is suitable for any drone from 3 inch up to large 10 inch builds and matches the needs a pilot has to fly accurately. The robust anodized aluminium housing balances the need of strength and light weight in both ways. It weights just **27.5** grams without servo. But to complete the package a compact servo motor with a flexible arm is included too.

Thermal measurement range is from -10°C to 140°C and various values and settings can be configured in the On Screen Display (OSD).

The infrared camera is limited to 8.6 Hz and is not forced to be used in military applications. **InEL IR-Cam** is designed for:

- thermal hotspot detection
- wildlife observation
- search and rescue

For example:

Young fawns have no flight instinct till they are four weeks old. Every year numerous fawns die because of mowing operations. Those would be recognizable with drones in combination with infrared cameras. Current devices are too cost-intensive and organisations like the fire brigade have not enough equipment or time to satisfy the need.

Developed and manufactured in **Tyrol, Austria**. We are in touch with local hunters and farmers.

InEL IR-CAM can be fully integrated into a FPV ecosystem and is connectable to a Flight Controller via **MSP** protocol. This allows the user to switch between various thermal profiles and adjust parameters like temperature range, transparency and servo position live during flight. Default thermal profiles are ready for use, but there's also the opportunity to customize thermal profiles to everyone's needs. FC axis information can be taken to automatically adjust the servo tilt. This feature enables the possibility to spot in a defined angle while flying.

User Interface:

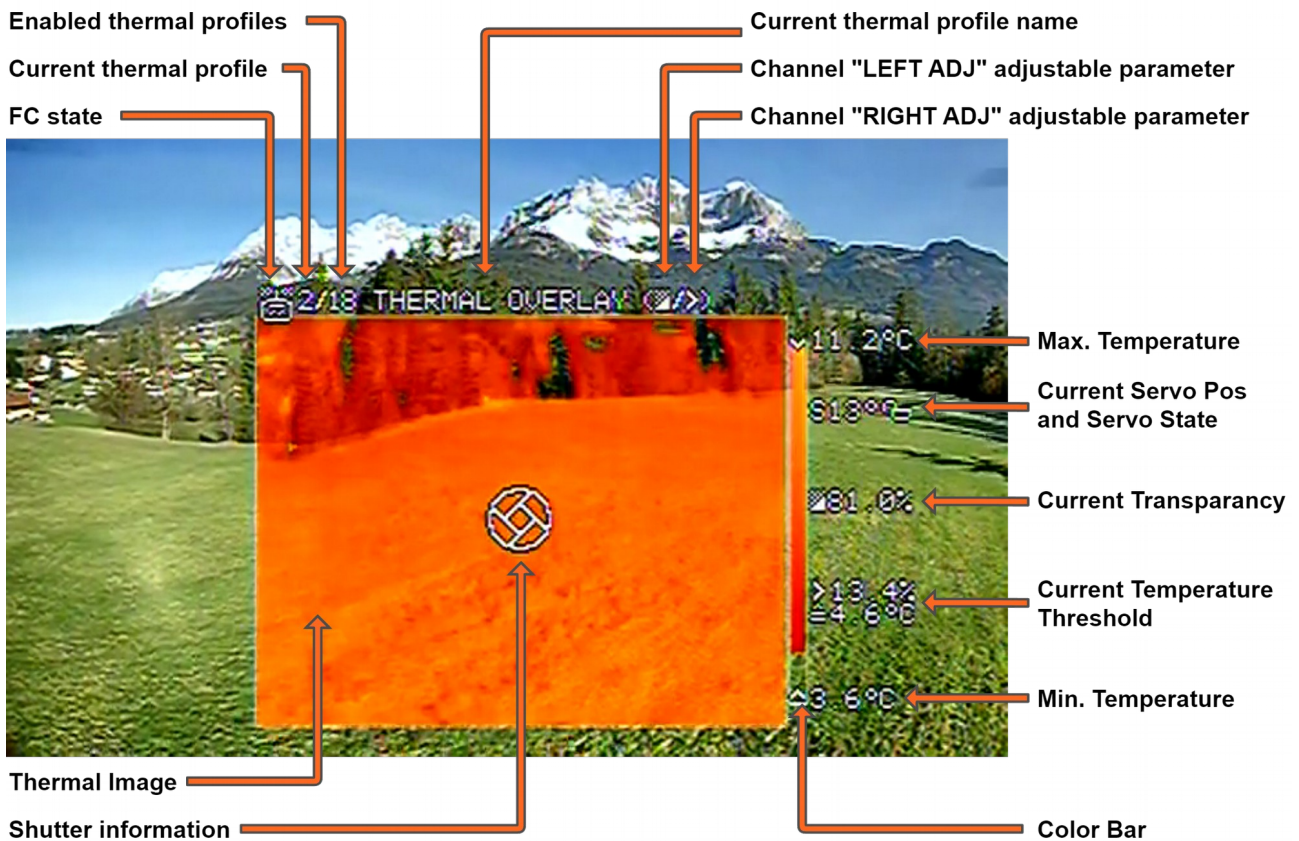

Default thermal profiles can be enabled or disabled in the settings. With an OSD keyboard connected the current profile can be changed by pressing LEFT or RIGHT. Preferred it can be switched via Remote Control (RC). To do so, a flight controller must be connected. Use the RC Channel "PROFILE" for switching between thermal profiles remotely.

The color bar shows the displayed thermal range. The current values of the parameters are displayed on the right side.

Flight Controller (FC) states:

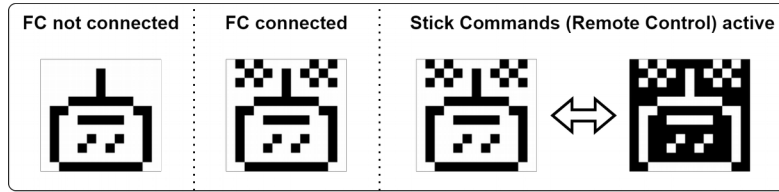

For user input a flight controller should be connected. If the FC is communicating the symbol “FC connected” appears. If you are using configuration over Stick Commands (RC) the state is toggling. Only with a FC connected user input via Radio Control is available.

Symbols adjustable parameters:

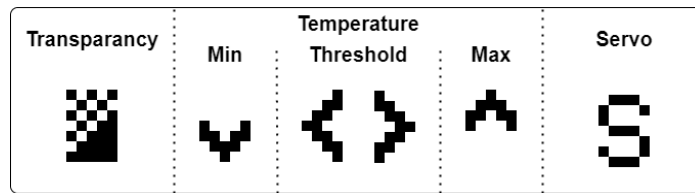

By configuring the RC Channel “PROFILE” you can switch between all enabled thermal profiles via radio control. With the RC Channels “LEFT ADJ” or “RIGHT ADJ” adjustable parameters can be changed in a defined range. We recommend using “range” channels. The active adjustable parameters are displayed. For more information about RC channels see chapter 5.3.

Shutter information:

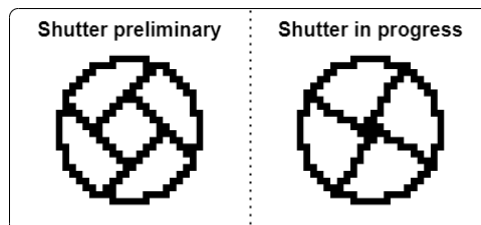

The thermal sensor has the ability of calibrating during usage. During shutter progress no thermal image is available. Visible image in this region will be black & white.

Servo states:

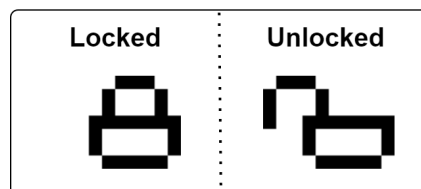

Servo is optional and can be deactivated. When locked, servo goes to locked position automatically. This leads to an easier use with ACRO flight modes. Unlocked conditions can be configured in the settings. For more information about servo functionality see chapter 5.5.



2. Box Content



IR-Cam Module
*adhere or remove
antler before flight

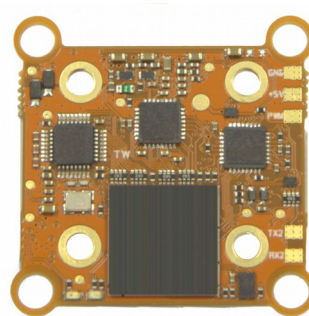

IR-Cam Base

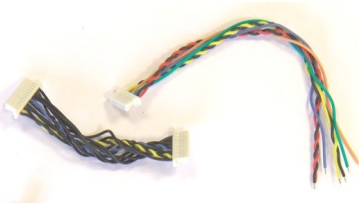

Cable
- 1x 12P, 100mm
- 1x 8P, 50mm



Accessories

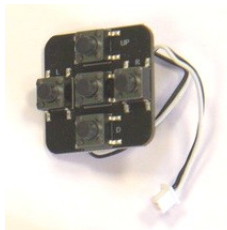

OSD Keyboard

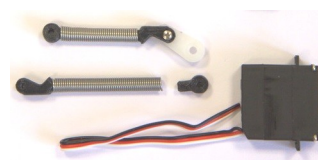

Servo
- 37mm arm
- up to 47mm
customizable arm



**Alternative Camera
Fixtures**
- 1x 10mm orange
- 1x 12mm black

Quick-Start



3. Dimensions

IR-Cam Module:

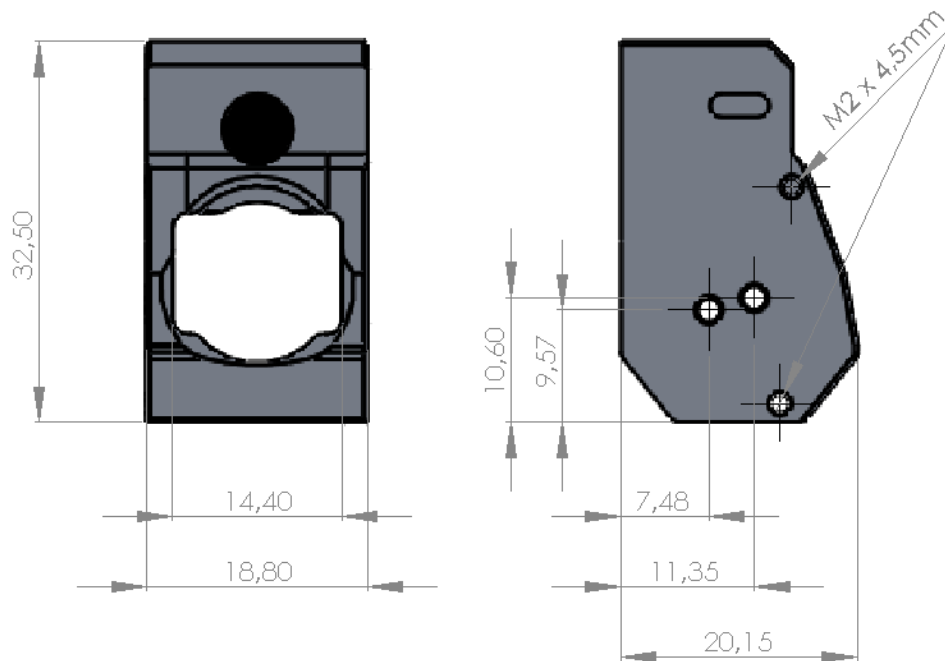

IR-Cam Base:

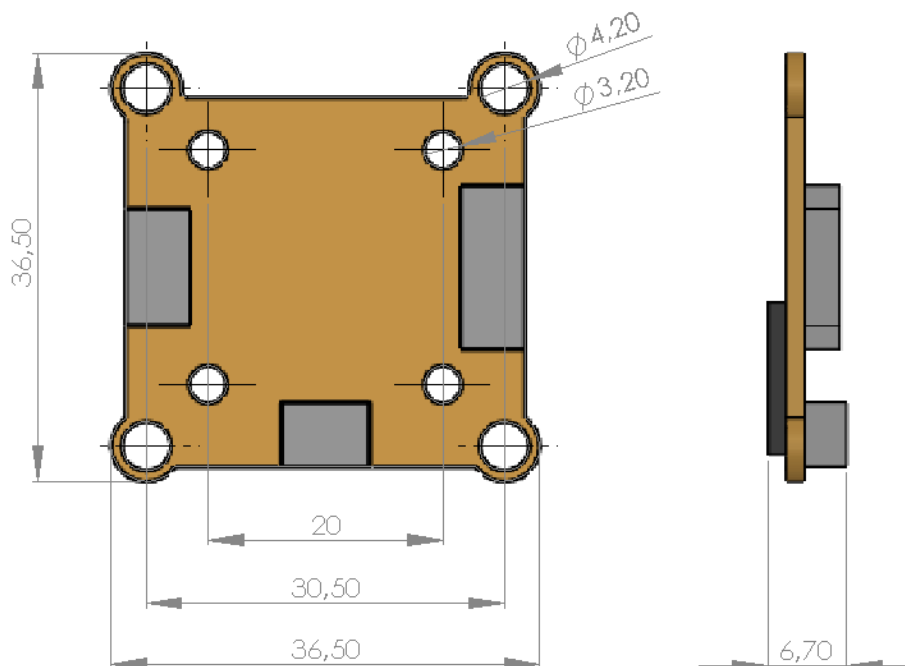

The outer mounting holes can be removed to save space. The asymmetrical design provides additional space on one side for usage with a servo motor.

4. Setup Hardware

4.1 Flight Controller (FC)

For FC firmware we recommend using **INAV** which fits best to the system. It comes with features like NAV POSHOLD Hold and NAV Waypoints Missions. Of course **Betaflight** is supported too. Other firmware with MSP may work, but is not verified.

The used serial interface of the flight controller must be configured to **MSP TX/RX** at **115200 Baud**.

To unlock the servo motor, you have to set one of the three Camera Control modes. The aux channel can be chosen freely.

INAV:

Ports DOCUMENTATION

Note: not all combinations are valid. When the flight controller firmware detects this the serial port configuration will be reset.
Note: Do NOT disable MSP on the first serial port unless you know what you are doing. You may have to reflash and erase your configuration if you do.

Identifier	Data	Telemetry	RX	Sensors	Peripherals
USB VCP	<input checked="" type="checkbox"/> MSP 115200	Disabled AUTO	<input type="checkbox"/> Serial RX	Disabled 115200	Disabled 115200
UART1	<input type="checkbox"/> MSP 115200	Disabled AUTO	<input type="checkbox"/> Serial RX	Disabled 115200	TBS SmartAudio 115200
UART2	<input checked="" type="checkbox"/> MSP 115200	Disabled AUTO	<input type="checkbox"/> Serial RX	Disabled 115200	Disabled 115200
UART3	<input type="checkbox"/> MSP 115200	Disabled AUTO	<input checked="" type="checkbox"/> Serial RX	Disabled 115200	Disabled 115200
UART4	<input checked="" type="checkbox"/> MSP 115200	Disabled 115200	<input type="checkbox"/> Serial RX	Disabled 115200	Disabled 115200
UART6	<input type="checkbox"/> MSP 115200	Disabled AUTO	<input type="checkbox"/> Serial RX	GPS 115200	Disabled 115200

➔ Save and Reboot

FPV Camera Modes

CAMSTAB

CH 6

Min: 1300 Max: 1700

CAMERA CONTROL 2 Alternative

CAMERA CONTROL 3 Alternative

ACRO ➔ Save

BETAFLIGHT:

Ports WIKI

Note: not all combinations are valid. When the flight controller firmware detects this the serial port configuration will be reset.
Note: Do NOT disable MSP on the first serial port unless you know what you are doing. You may have to reflash and erase your configuration if you do.

Identifier	Configuration/MSP	Serial Rx	Telemetry Output	Sensor Input	Peripherals
USB VCP	<input checked="" type="checkbox"/> 115200	<input type="checkbox"/>	Disabled AUTO	Disabled AUTO	Disabled AUTO
UART1	<input type="checkbox"/> 115200	<input type="checkbox"/>	Disabled AUTO	Disabled AUTO	Disabled AUTO
UART2	<input type="checkbox"/> 115200	<input type="checkbox"/>	Disabled AUTO	Disabled AUTO	Disabled AUTO
UART4	<input type="checkbox"/> 115200	<input checked="" type="checkbox"/>	Disabled AUTO	Disabled AUTO	Disabled AUTO
UART5	<input checked="" type="checkbox"/> 115200	<input type="checkbox"/>	Disabled AUTO	Disabled AUTO	Disabled AUTO

➔ Save and Reboot

Port utilization: D: 0 % U: 0 Packet error: I2C error: Cycle Time: CPU Load: 31 Configurator: 10.9.0 (697943b) , Firmware: 4.4.2.BTFL , Target:



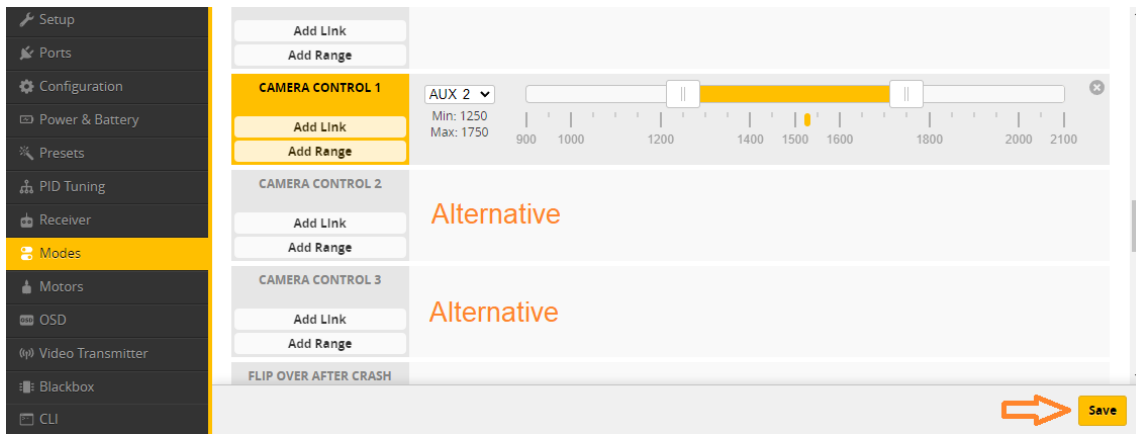

4.2 IR-Cam Base

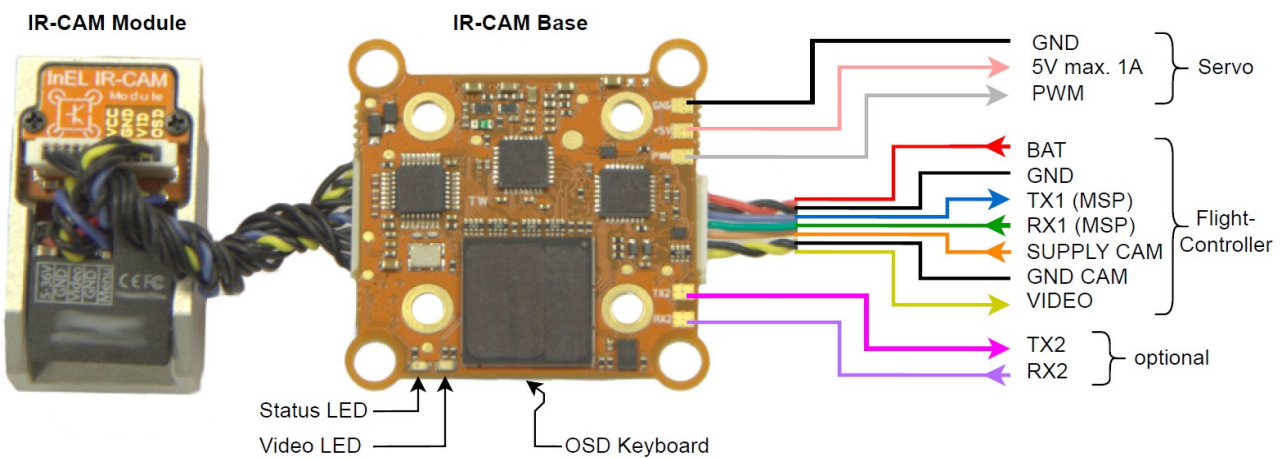

Solder the wires to the Flight Controller. For the best image quality keep the cable length as short as possible and twist the cables.

POWER SUPPLY:

You can use the IR-Cam with and without a servo motor. The recommended servo is already included in the package. When using the servo motor the input voltage **BAT** must be between 7 and 28V. Without servo the system can be powered with 5V at 500mA and up to 28V. Twist **BAT** with **GND**.

SERIAL INTERFACE:

It can be chosen between serial interface 1 or 2 can. They have the same functionality, but only one can be connected at a time. Solder the **TX** of the IR-Cam Base to **RX** of the FC and **RX** of the IR-Cam Base to **TX** of the FC.

VIDEO and SUPPLY CAM:

SUPPLY CAM is passed through and depends on the used visible image FPV camera. The maximum voltage is **28V** because of the used filters. The included camera (RunCam Phoenix 2 Nano) is capable of this range with minimum **5V**. Twist SUPPLY CAM with GND CAM and VIDEO for the best image quality.

4.3 IR-Cam Module

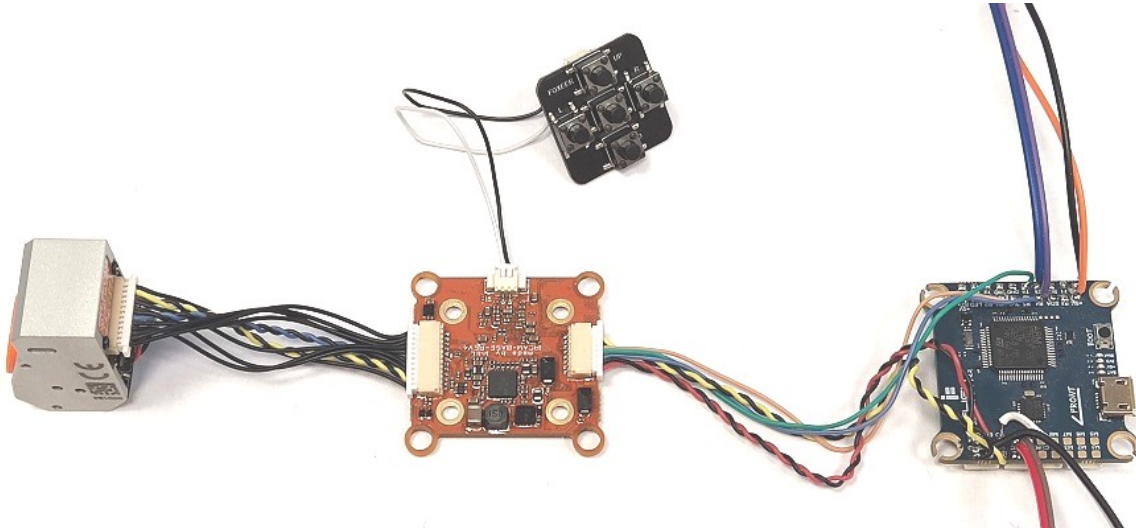

To connect the IR-CAM Module with the Base use the 12 pinned cable. Please make sure the yellow video cable is on the right side of the IR-CAM Module. Handle with care when plugging and unplugging.

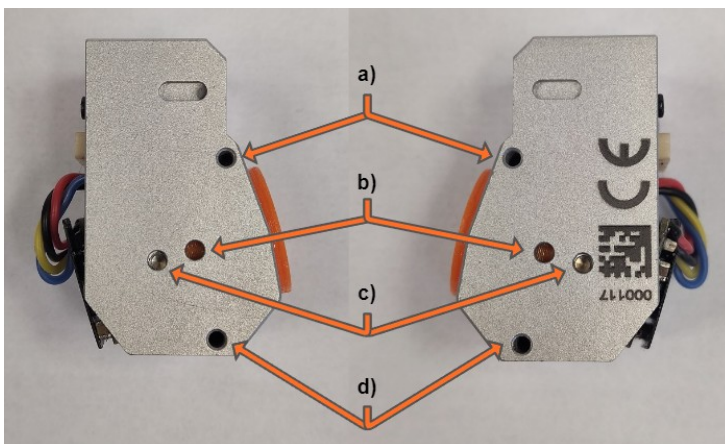

a) servo mounts outside

b) alternate mounts for other sized FPV cameras

c) FPV camera mounting holes. make sure, that the threads match the holes

d) servo mounts inside

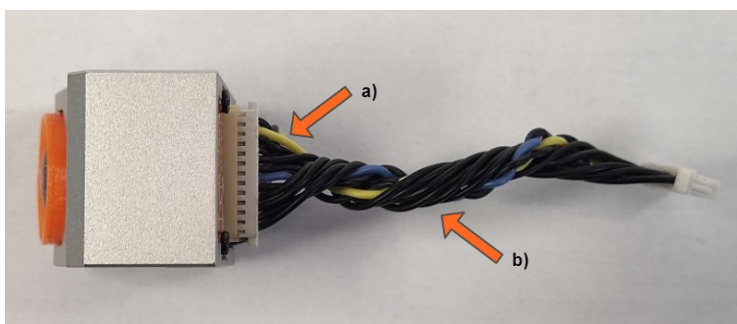

a) make sure the yellow video cable is on the right side

b) twist the whole cable for the best video quality

4.4 1-axis Gimbal (Servo)

If you want to use the 1-axis gimbal feature, you need camera holders which fits to your frame. You can find chosen ones on our homepage. Use those designs as a starting point.

Not every FC has a servo output, so we decided to put one onto InEL IR-Cam for the best compatibility. When the FC has a servo output feel free to use it in combination with all INAV features. If you have limited channel count on your RC, using the integrated servo control can be useful too.

Servo Holder Inside (recommended for best durability)

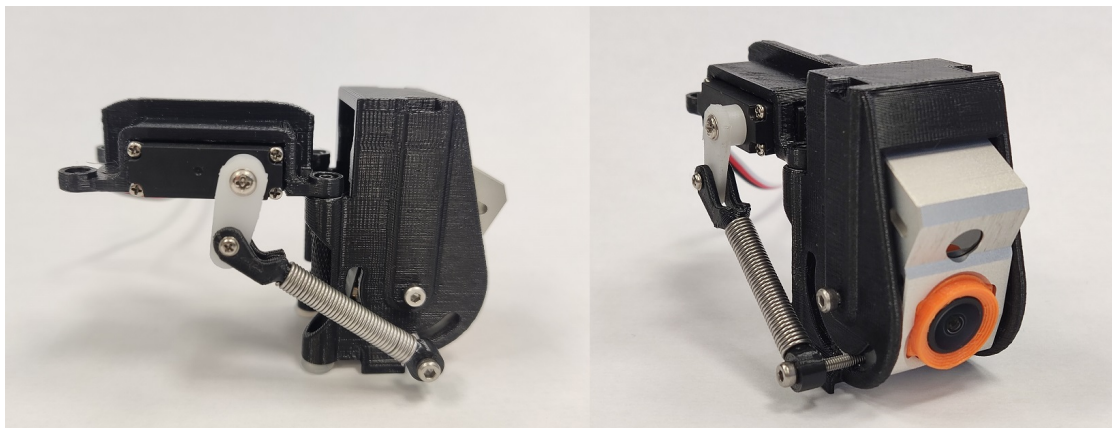

Servo Holder Outside

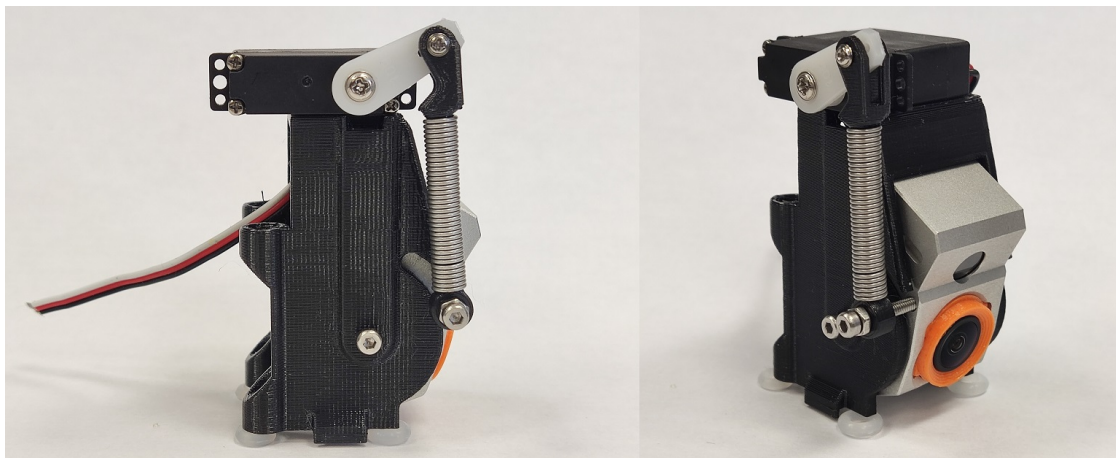

Customize servo spring:

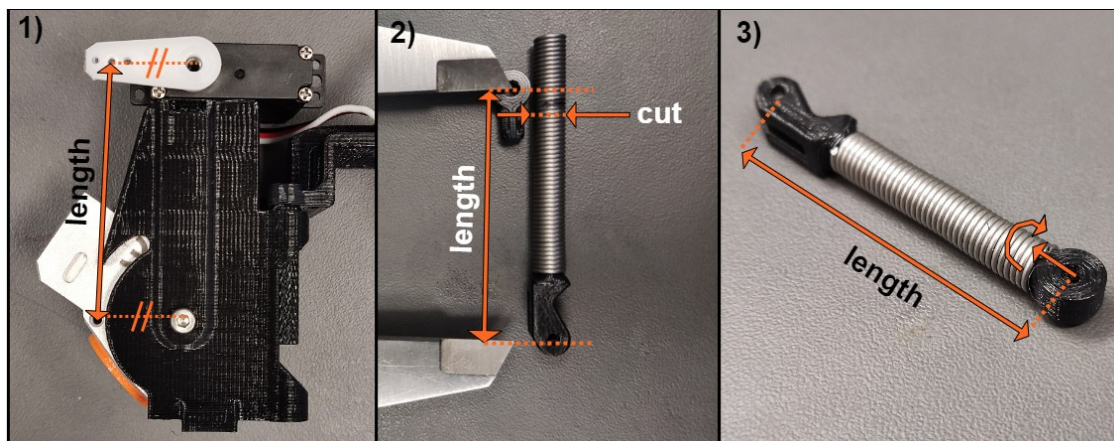

- 1) Start defining the necessary length. Servo and IR-Cam should be in middle position and in parallel
- 2) Cut the spring so you can reach the defined length in combination with the end piece.
- 3) Insert the end piece by pressing and rotating until the desired length is reached

Customize servo arm:

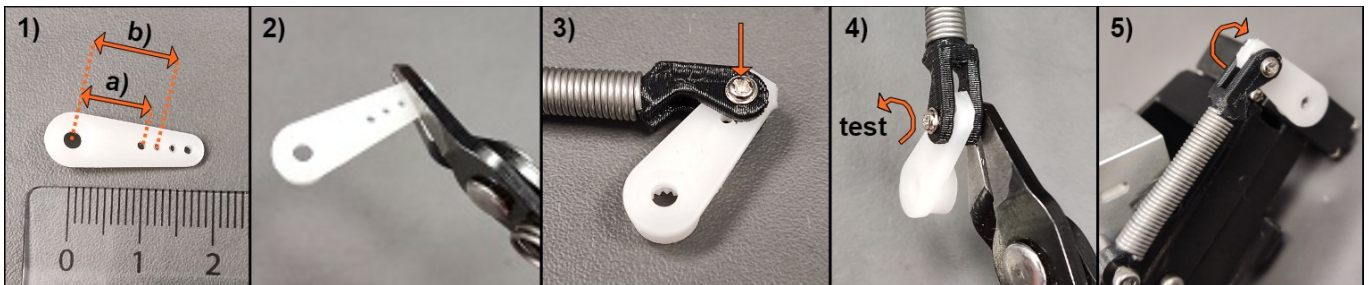

- 1) Measure the distance of the cam mounting hole to the servo mounting hole. Use the hole on the servo arm which matches the distance best.
 - a) 10mm
 - b) 12mm
- 2) Shorten the servo arm
- 3) Drill the screw into the chosen hole
- 4) Test if it's easy rotating, otherwise adjust the screw. Cut the protruding screw carefully.
- 5) Mount on servo

General tips for servo mounting:

After successful testing use medium strength screw adhesive for the best reliability.

At small frames with 20x20mm mounting holes, it can be necessary to remove one of the bigger mounting holes.

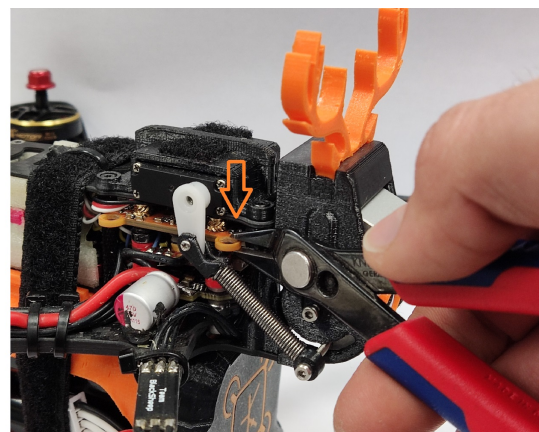
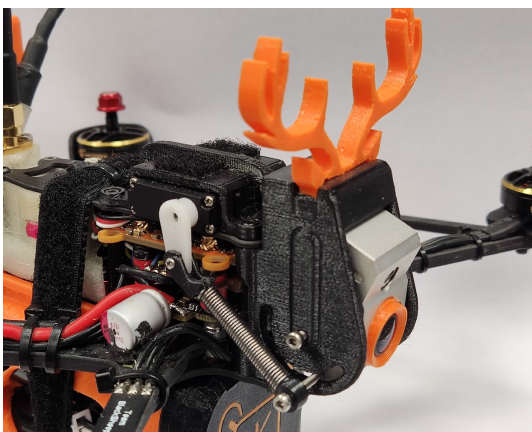

5. Settings

To enter the settings you can connect the included OSD keyboard and press **ENTER**. If your MSP connection (FC) is working you can also use OSD Stick Commands (RC). The stick commands are in Mode 2 (AETR1234) only.

Configuration over OSD Keyboard	Configuration over Stick Commands (RC) Mode 2 Remote Control
	<p>1 second CONNECT Throttle/Yaw Roll/Pitch</p> <p>1 second DISCONNECT Throttle/Yaw Roll/Pitch</p> <p>ENTER Throttle/Yaw Roll/Pitch</p> <p>LEFT Throttle/Yaw Roll/Pitch</p> <p>RIGHT Throttle/Yaw Roll/Pitch</p> <p>UP Throttle/Yaw Roll/Pitch</p> <p>DOWN Throttle/Yaw Roll/Pitch</p>

- Press **ENTER** to go to the main settings
- >> Press **UP** or **DOWN** to choose
- ◀ Value ▶ Press **LEFT** or **RIGHT** to edit value
- ↶ Press **ENTER** to change page

In the settings you are able to control the FPV camera via passthrough, setup your RC channels, adjust the thermal overlay position and other thermal characteristics. All settings are preview in real time.

Thermal profiles can be selected and customized.

This product supports firmware updates. To check your current version, the **“INFORMATION”** page can be used.

With **“RESET ALL SETTINGS”**, all parameters including the thermal profiles are set to default value.

If settings are changed and should be saved **„SAVE AND EXIT“** has to be used. To cancel unwanted changes, **EXIT** can be used.

MAIN SETTINGS

- FPV CAM PASSTROUGH ↶
- RC SETTINGS ↶
- THERMAL SETTINGS ↶
- SERVO SETTINGS ↶
- THERMAL PROFILE SELECTION ↶
- INFORMATION ↶
- RESET ALL SETTINGS ↶
- SAVE AND EXIT ↶
- EXIT ↶



5.1 Quick Setup (Overview)

After mounting InEL IR-Cam into a frame follow these steps for a quick and easy setup. Steps can be skipped if the default values suit.

To set the configuration permanently use “**SAVE AND EXIT**”.

1) Setup the FPV camera settings (FPV Cam Passthrough)

Default:

- VIDEO STANDARD: PAL
- IMAGE RATIO: 4:3

Setup: see chapter 5.2

2) Setup remote control channels for the thermal profiles (RC Settings)

Default:

- RC “PROFILE” TYPE: toggle switch
- RC “PROFILE” CHANNEL: CH 8/Aux 4
- RC “LEFT_ADJ” CHANNEL: CH 9/Aux 5
- RC “RIGHT_ADJ” CHANNEL: CH 10/Aux 6
- RC STICK COMMANDS: enabled

Setup: see chapter 5.3

3) Setup the thermal overlay position (Thermal Settings)

Default:

- x/y position, x/y scale: 180 / 258, 2.24 / 2.41
- orientation: right side up
- temperature unit: °C

Setup: see chapter 5.4

4) Setup position range of the servo motor for 1-axis gimbal (Servo Settings)

Default: enabled

Setup: see chapter 5.5

5) Enable/disable default profiles (Thermal Profile Selection)

Default: already enabled thermal profiles

Setup: see chapter 5.6

6) Save and Exit

5.2 FPV Camera Passthrough

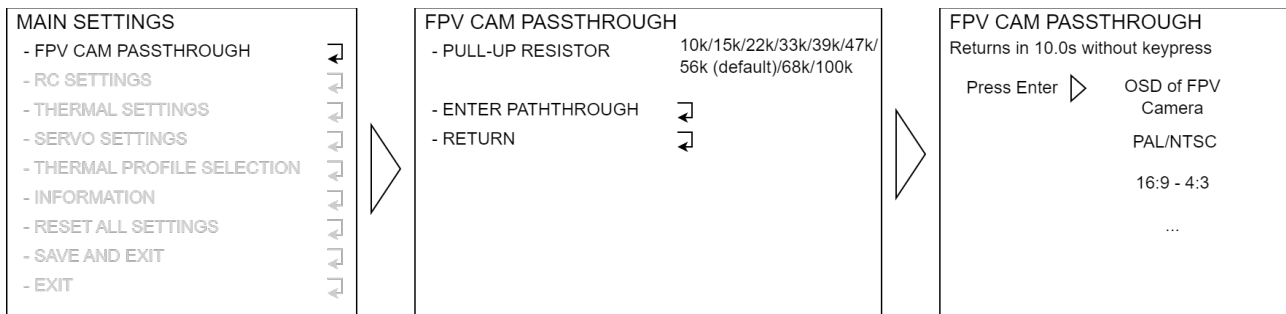

To be compatible with different kinds of FPV cameras the internal pull up resistor can be chosen. For the included camera, the default value is correct.

The passthrough mode is cancelled if 10 seconds no key input is detected. So when exiting the Cam OSD wait 10 seconds and it returns automatically.

5.3 RC Settings

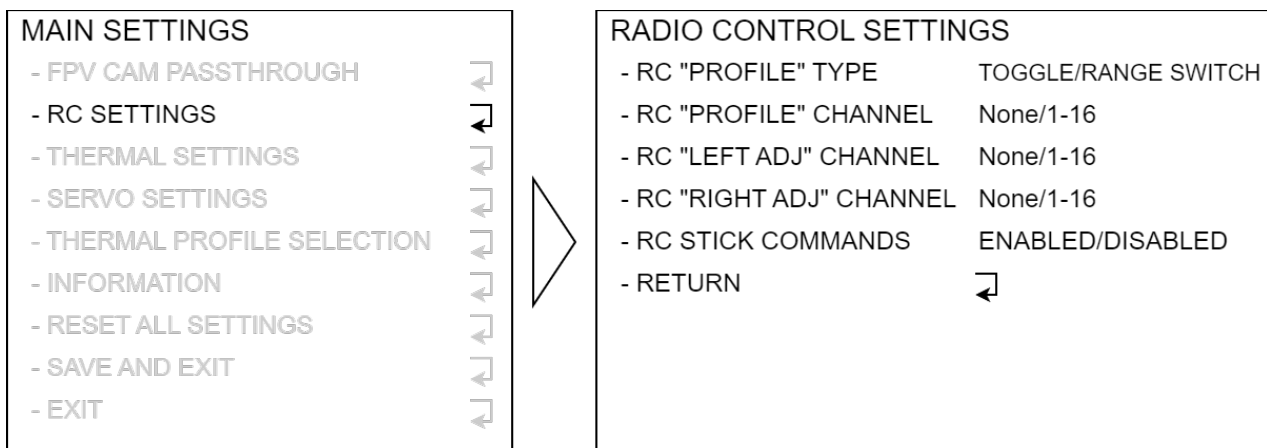

For the best experience you are able to control the thermal profile and servo with your radio controller. To do so, you have to choose the channels of your RC in the **RC SETTINGS** page. We recommend using "range/analog" channels for "**LEFT ADJ**" and "**LEFT ADJ**". For "**PROFILE**" the type can be chosen.

RC "PROFILE" TYPE:

To be able to change the profile, the channel can be used as toggle switch (each toggle, changes to the next profile) or as range switch (the count of profiles is distributed to channel range).

RC "PROFILE" CHANNEL:

This channel is used to switch between thermal profiles

RC "LEFT ADJ" CHANNEL:

This channel is used to modify the value of left sided adjustable parameters

RC "RIGHT ADJ" CHANNEL:

This channel is used to modify the value of right sided adjustable parameters

5.4 Thermal Settings

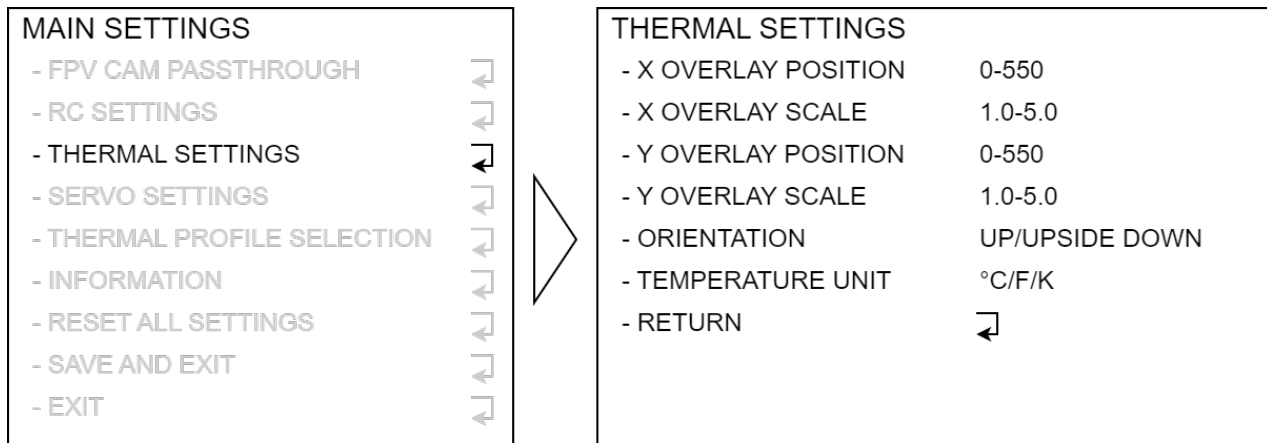

Due to the mounting, the of thermal sensor relating to the FPV camera is shifted. Use X and Y Overlay position to match the thermal image with the visible image.

If you change the IMAGE RATIO of the FPV camera, also the scaling must be updated.

OVERLAY POSITION AND SCALE:

Proceed as follow:

1. define a thermal hotspot in a distance of 20m or farther
2. view the thermal hotspot at the top left corner of the thermal image
 - adjust X overlay position
 - adjust Y overlay position
3. view the thermal hotspot at the top right corner of the thermal image
 - adjust X scale
4. view the thermal hotspot at the bottom center of the thermal image
 - adjust Y scale

Todo: pictures?

ORIENTATION:

When mounted upside down, the thermal image can be rotated

TEMPERATURE UNIT:

Change unit of the temperature values which are displayed in the OSD

5.5 Servo Settings

MAIN SETTINGS	
- FPV CAM PASSTHROUGH	↩
- RC SETTINGS	↩
- THERMAL SETTINGS	↩
- SERVO SETTINGS	↩
- THERMAL PROFILE SELECTION	↩
- INFORMATION	↩
- RESET ALL SETTINGS	↩
- SAVE AND EXIT	↩
- EXIT	↩

SERVO SETTINGS	
- SERVO ENABLE	ENABLED/DISABLED
- TEST POSITION	0.0-100.0%
- DIRECTION	NOT INVERTED/INVERTED
- MINIMUM POSITION	0-180°
- MAXIMUM POSITION	0-180°
- SCALE FOR AUTO MODE	0.5-1.5
- LOCKED POSITION	0.0-100.0%
- UNLOCK AT MODES	ALL/*/NONE
- RETURN	↩

*CAMERA CONTROL 1, 2, 3



ATTENTION:

When the servo is enabled, it turns to test position automatically. Configuration with unmounted servo arm recommended.

SERVO ENABLE:

when the internal servo feature is not used, it can be disabled. All servo visualisations are disabled too then.

TEST POSITION:

During this setup the motor stays in it's test position.

DIRECTION

Instead of changing your RC Channel you can invert the servo positioning via this setting.

MINIMUM & MAXIMUM POSITION:

Every setup is different, to limit servo positioning minimum and maximum angle has to be set. The min. angle can not be larger than the max. angle and vis versa.

LOCKED POSITION:

The servo motor goes in this position when in **Locked State** automatically. This can be used when the drone pilot is changing from Position Hold to Angle/Acro mode.

UNLOCK AT MODES:

To unlock the servo, modes have to be chosen. When using **NONE**, servo is always locked and can not be moved. When using **ALL**, servo is always unlocked and does not go to locked position automatically. When using **Camera Control 1, 2, 3** servo is only unlocked if the chosen Camera Control is active or the drone is disarmed.

5.6 Thermal Profile Selection

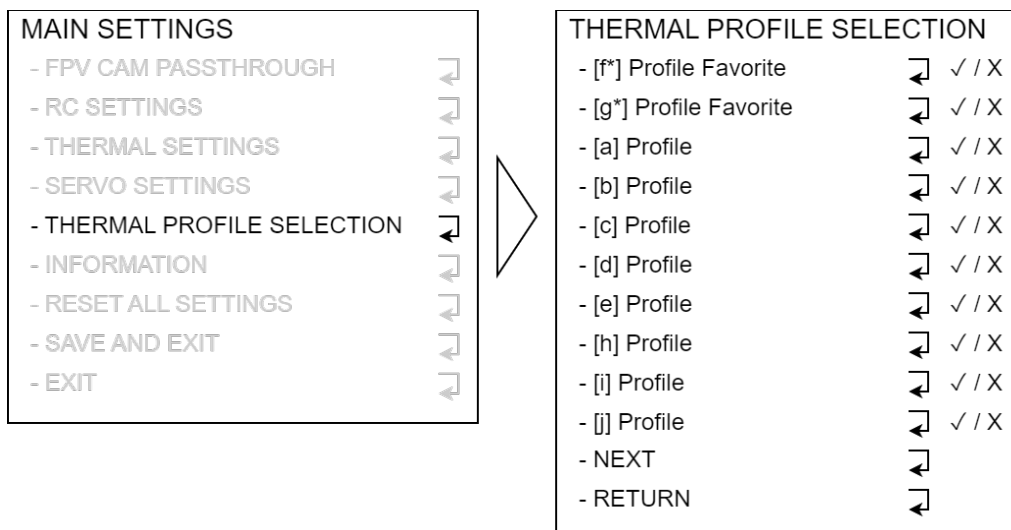

By pressing LEFT or RIGHT you can enable or disable the selected thermal profile. Favourites and enabled Profiles are listed sorted. A preview of the current selected profile without UI is shown.

Example profiles:

THERMAL AUTO/DEFAULT/USER1:

- IR Position: Overlay
- IR Color: hot yellow, cold red
- Transparency: Auto/Fix, 75%
- Temperature min: Auto, > -10°C
- Temperature Threshold: Auto, ~50% thermal image
- Temperature max: Auto, < 140°C
- Servo: Default

WILDLIFE:

- IR Position: Overlay
- IR Color: hot yellow, cold red
- Transparency: Fix, 80%
- Temperature min: Auto, > 0°C
- Temperature Threshold: Adj, "RC-RIGHT-ADJ", 0-100%
- Temperature max: Auto, < 50°C
- Servo: Adj, "RC-LEFT-ADJ", 0-100%

5.7 Setup thermal profiles (Advanced)

THERMAL PROFILE EDIT

- NAME	USER1/USER2/...
- FAVORITE	YES/NO
- IR RANGE	NONE/ < THRESHOLD/ > THRESHOLD / FULL
- IR POSITION	SMALL/BIG/OVERLAY
- IR COLOR	RED/BW/BLUE/...
- IR THRESHOLD TYPE	ABSOLUTE/PERCENTAGE
- TRANSPARANCY	↩ PREVIEW*
- TEMPERATURE MIN	↩ PREVIEW*
- TEMPERATURE THRESHOLD	↩ PREVIEW*
- TEMPERATURE MAX	↩ PREVIEW*
- SERVO	↩ PREVIEW*
- RETURN	↩

PARAMETER EDIT

- MODE	ADJ/AUTO/FIX/DFLT
- RC CHANNEL	LEFT ADJ/RIGHT ADJ
- VALUE	min-max
- MIN	min-max
- MAX	min-max
- RETURN	↩

*PREVIEW: MODE/CHANNEL/VALUE/MIN/MAX

Press **ENTER** at the selected thermal profile. In the advanced setup every profile parameter can be adjusted to your needs.

PARAMETER EDIT:

ALL:

Mode AUTO: see description below

Mode ADJ: Adjust parameter in configured range

Mode FIX: Set parameter to a fixed value

Mode DFLT: keep last value

TRANSPARENCY:

Mode AUTO: sets transparency to 75% and removes transparency icon from OSD

TEMPERATURE MIN:

Mode AUTO: sets temperature min to the lowest temperature of the current thermal view

TEMPERATURE THRESHOLD:

Mode AUTO: sets threshold temperature, so 50% of the thermal picture are displayed

TEMPERATURE MAX:

Mode AUTO: sets temperature max to the highest temperature of the current thermal view

SERVO:

Mode AUTO: Adjust servo position between configured range. A FC must be connected to use the axis information to automatically adjust the servo tilt. This feature enables the possibility to spot in a defined angle while flying.

6. Firmware Update

You can connect your system to our online update tool. You can access it with your web browser (compatible with Chrome and Edge). When connected to a FC, select the used serial port and connect the FC via USB. Please make sure InEL IR-Cam is powered too.

The update tool is available at: www.inel-fpv.at/updater

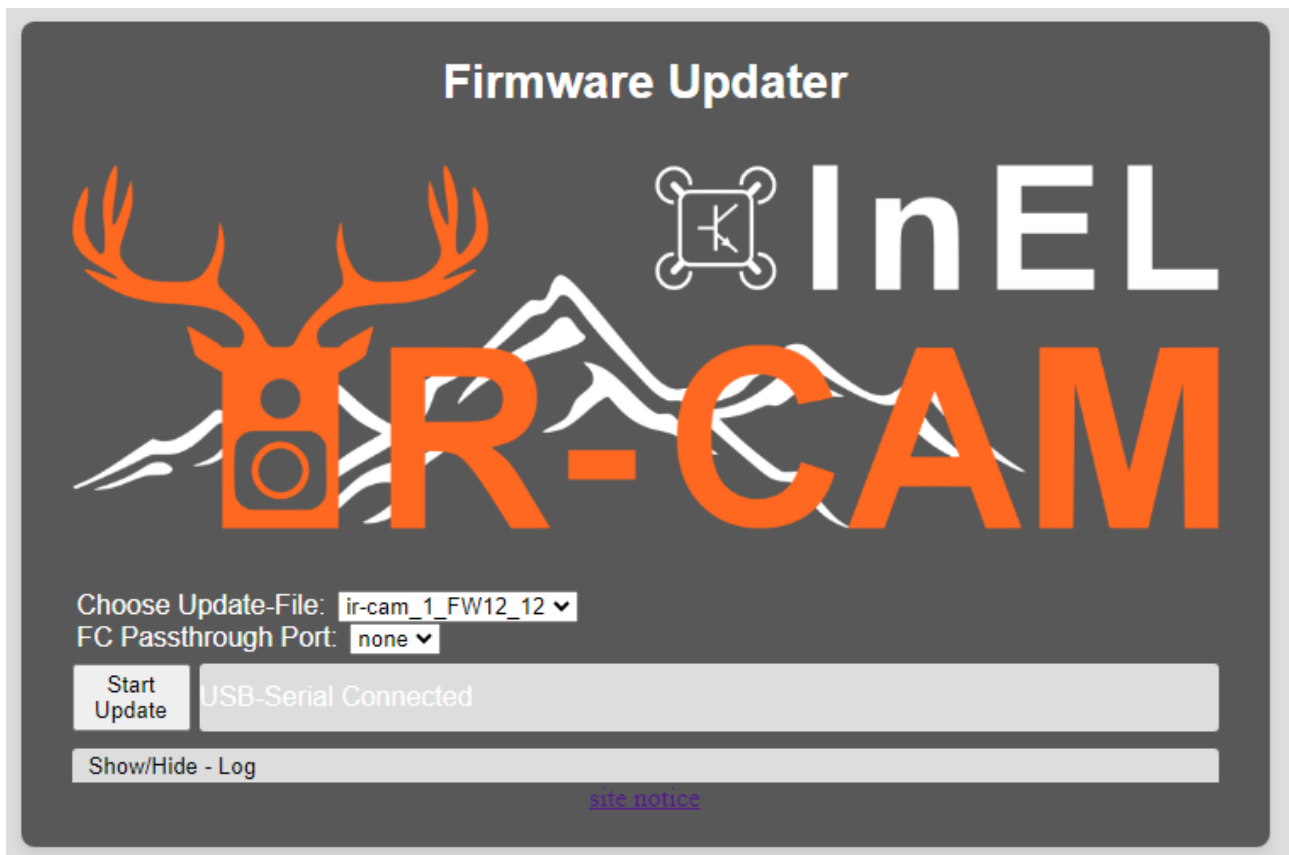

Firmware 14.2 is published. The description of the new functions will be added to the manual soon.

7. Specifications

Supply voltage (BAT)	7-28V with Servo 5V (500mA)-28V without Servo
Operating temperature	0-60 °C
Video output	PAL/NTSC
Additional video latency	< 100µs
Thermal sensor	Lepton 3.5 (120x160 @8.7Hz)
FPV camera	RunCam Phoenix 2 Nano
Mounting hole distance	20x20 mm, 30.5x30.5mm
Weight (Base + Module)	27.5 grams

8. Compliance



For more information on compliance, see:

<https://www.inel-fpv.at/downloads/compliance>

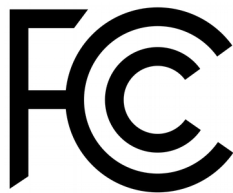

WEEE/ElektroG

This symbol indicates that this product must not be disposed of as household waste under the WEEE Directive (Waste Electrical and Electronic Equipment Directive) and national laws. This product must be returned to a dedicated collection site.



9. Safety information

- this product is designed for technically savvy hobbyist.
- this product needs integration in a system (FPV) to operate.
- this product is designed for recreational use.
- this product does not meet functional safety criteria.

10. Help / Troubleshooting

I have no video stream. What can I do?

- 1) Check the Video-LED. If it's green video passthrough is active
- 2) Check the Status-LED
 - fast blinking, everything is OK
 - blinking 2 times between long break:
FPGA design is not valid, please make a firmware update
 - short blinking every second
It's in bootloader mode. Powercycle or make firmware update
- 3) Check wiring to FC
- 4) If you see the thermal frame but a black image check wiring to the IR-Cam Module

I have no thermal image. What can I do?

- 1) Check the Status-LED
 - fast blinking, everything is OK
 - blinking 1 times between long break:
Any Error message in the OSD? Powercycle
- 2) Check the thermal profile
Is the thermal image enabled?
- 3) Check the thermal settings
Is the position of the overlaid thermal image in visible region?

I have no FC connection. What can I do?

- 1) Check the port settings of your flight controller firmware
- 2) Verify serial port on your board. Sometimes Serial Port 1 of the board does not match with Serial Port 1 in the FC firmware
- 3) Check FC firmware
INAV version 5.1-7.1 and Betaflight 4.2 are verified

My thermal image does not match with the visible image

→ setup thermal settings, see chapter 5.4

My temperature reading is not correct

The thermal sensor has an accuracy of 5%. At large distances the thermal hot spot is too small for the thermal pixel size which leads to a smaller temperature reading. Temperature reading can get also wrong if the camera system is getting too hot.